

HYUNDAI
POWER PRODUCTS

PETROL POLE PRUNING MACHINE

HPS5230



GENUINE PRODUCT OF
HYUNDAI CORPORATION

ORIGINAL INSTRUCTIONS

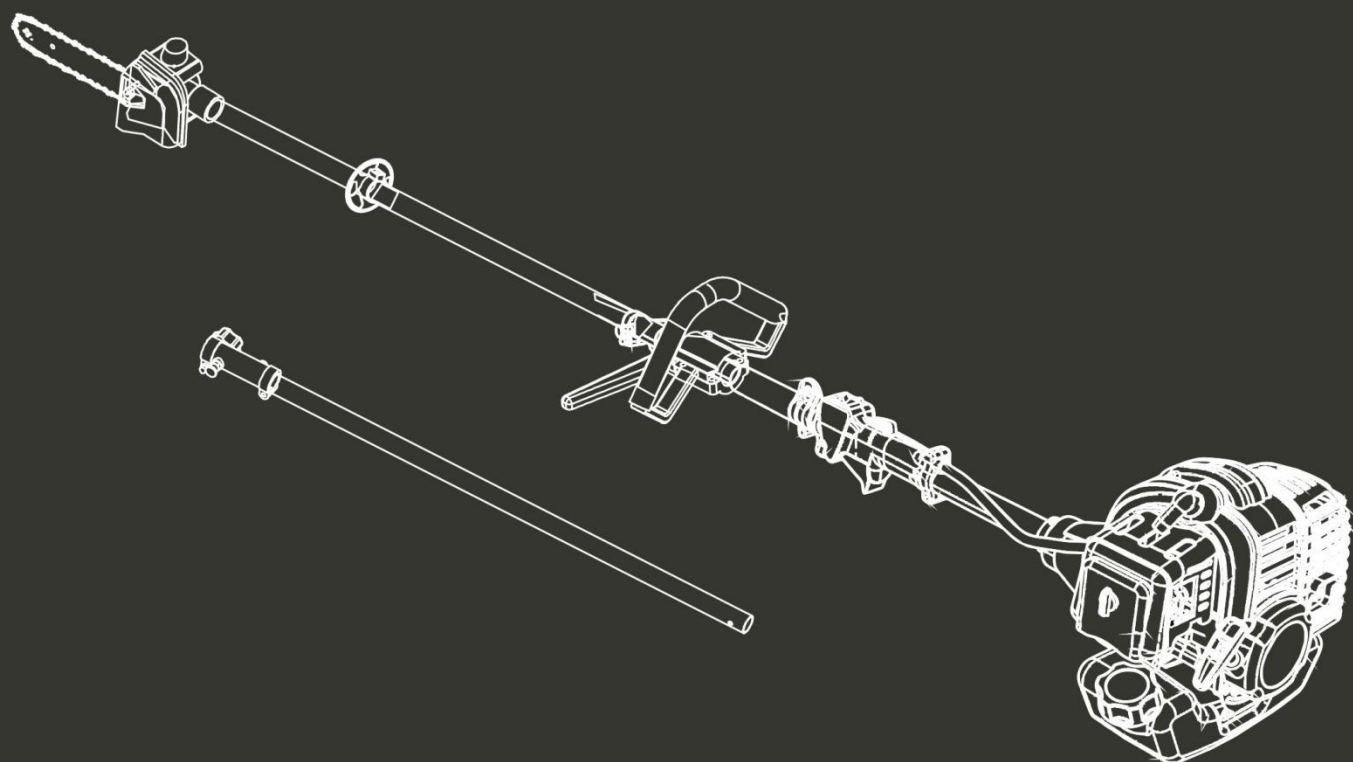

WARNING: Read thoroughly the instruction manual before using.

CONTENTS

1. INTENDED USE.....	3
2. SAFETY INSTRUCTIONS.....	3
3. YOUR PRODUCT.....	8
4. ASSEMBLY.....	9
5. FUEL TANK.....	11
6. UTILISATION.....	12
7. CARE AND MAINTENANCE.....	14
8. TRANSPORT AND STORAGE.....	16
9. TECHNIQUE INFORMATION.....	16
10. TROUBLESHOOTING.....	17
11. DECLARATION OF CONFORMITY.....	18
12. WARRANTY.....	19
13. PRODUCT FAILURE.....	20
14. WARRANTY EXCLUSIONS.....	21

1. INTENDED USE

The pole pruner is exclusively intended for pruning trees and/or cutting small wood from the ground. Any other use is considered improper and will damage the tool.

The correct use also includes reading and observing the instructions for use at each use as well as observing the warnings fixed on the machine. Before and during use, it is imperative to check the blade to ensure that there is no mechanical damage. In case of necessary repairs, please contact your specialist dealer.

Only the use of spare parts approved by the manufacturer or original spare parts is permitted. If unauthorized or non-original spare parts are used, the user is liable for consequential injury to persons or property resulting in the manufacturer being deprived of all liability.

Residual risks

Even if you use this product in compliance with all safety requirements, the potential risks of injury and damage remain. The following hazards may arise in the structure and design of this product:

- There are harmful health consequences resulting from the emission of vibrations if the product is used for long periods of time or not properly managed and properly maintained.
- There is risk of injury and property damage due to attachments or broken the sudden impact of hidden objects when using cutting.
- Risk of injury to persons and property caused by flying objects.
- Prolonged use of this product exposes the operator to vibration and can produce so-called "white finger" disease. To reduce the risk, wear gloves and keep your hands warm.
- If any of the symptoms of "white finger syndrome" occur, seek immediate medical attention. Symptoms of the "white finger" include numbness, loss of sensitivity, tingling, tingling, and pain, loss of strength, color changes or skin condition. These symptoms usually appear on the fingers, hands or wrists. Risk increases at low temperatures.
- There is a risk of loss hearing if the user is exposed for a long time to the noise and specifically if a hearing protection is not worn.

2. SAFETY INSTRUCTIONS

General safety instructions

If you feel an unpleasant sensation in the hands or if you see a coloring of the skin of your hands while using the machine, stop the work immediately. Have enough breaks when working. Failure to observe sufficient work breaks may result in hand and arm vibration syndrome.

It is thus necessary to assess this impact according to the work carried out or the use of the machine and to take breaks accordingly. This greatly reduces the impact on the user during the entire working period. Minimize your risk of vibration. Maintain this machine in accordance with the instructions in the operating instructions.

If the machine is used frequently or more regularly, we recommend that you contact your specialist dealer for anti-vibration accessories (handles) if necessary.

Avoid using the machine at temperatures of $t = 10^{\circ}\text{C}$ or lower. Develop a load plan to limit the impact of vibration on the user.

Read this manual carefully before operating the machine for the first time. In case of doubt about the connections or its use, please contact the manufacturer (specialist dealer).

In order to guarantee a high level of safety, the following instructions must be strictly adhered to.

Warning!

To ensure safety at work with this pole pruner, it is essential to strictly follow the instructions and to take into account the safety, assembly and use information contained in this manual. Anyone using or performing maintenance work on the machine must be familiar with and familiar with these instructions in order to be aware of all possible risks. Prevent children, sick or impaired

people from accessing the machine. As you stand in the work area, be aware of the presence of children. Observe local or regional safety precautions in your area. This also applies to all provisions relating to safety at the workplace and to health prevention in the workplace. Bystanders must be kept at a safe distance from the machine during operation.

The manufacturer must not be held liable if the machine has been modified in an unauthorized manner or in such a way as to constitute ultimately damage.

Warning!

It is essential to observe the safety instructions required when using the machine.

Observe the instructions and notes in the enclosed safety instructions.

1. Consider the nature of the area where the work is performed. After starting the machine, it produces toxic exhaust gases. These gases are invisible and odorless. Therefore, it is imperative never to use the machine in closed or poorly ventilated spaces. When cutting, make sure you have good lighting. Ensure stability when working on slopes or on uneven surfaces in the presence of moisture, snow or thaw.
2. Do not allow unauthorized persons to approach the machine. Visitors and spectators, mainly children, the sick or impaired, must not be allowed access to the work area. Prevent other people from touching the tool.
3. Take precautions when storing the tool. When the machine is not in use, it must be stored in a dry place, if possible raised or protected, in order to prevent access.
4. Always use the right tool for the jobs you want to perform. In this context, it is advisable, for example, to avoid using a tool or a small accessory for work requiring the use of a heavy tool. Use the tool only for the purpose for which it was designed.
5. Be sure to wear suitable clothing. Clothing should be appropriate and not hinder you in your work. Wear protective clothing that protects against cuts.
6. Use personal protective equipment. Wear slip-resistant foot protection as well as close-fitting clothes.
7. Wear safety goggles. Objects can be thrown into the eyes.
8. Wear ear protectors. Wear personal protective equipment to protect your ears, such as hearing protectors.
9. Protective gloves. Wear strong gloves. Leather gloves offer good protection.
10. Never work with an unsecured cutting tool. There is a risk of injury from projected objects.
11. Remove keys and tools required for assembly. Before starting the pruner, remove all the keys and so on.
12. Stay alert at all times. Be attentive to what you are doing. Make use of your common sense. Do not use the pruner when you are tired. Never use the tool under the influence of alcohol, drugs or drugs that alter or decrease concentration.
13. Filling the fuel tank. Before filling the fuel tank, always turn the engine off. Open the tank cover carefully, so as to be able to remove any excess pressure and prevent fuel from spurting out of the tank. During use of the pruner, high temperatures develop at the machine housing. Therefore, it is imperative to leave the machine cool before filling the fuel tank. Otherwise, the fuel may ignite spontaneously, which can cause burns. Filling the fuel tank means not filling the tank above the permitted limit. If fuel drops from the tank, it must be removed immediately before re-using the machine. After filling the tank, check that the screw connections are tight so that they do not come loose during work due to vibration.
14. Hours of work and breaks. After using the motorized machine for an extended period, you may be subject to circulation problems in your hands. While you have the possibility to extend the duration of use by wearing suitable gloves and taking breaks regularly. Please note that the operating time of the motorized machine is shortened due to discomfort of the user due to poor circulation, too low outside temperature or excessive driving power of the machine during the works.

15. Be alert to damaged components. Check the machine before using it. Are any components damaged? When you detect minor damage to the machine, ask yourself seriously whether the machine can still be used properly and safely. Ensure that the orientation and adjustment of the moving components are correct. Are the different components properly adjusted relative to each other? Are any of the components damaged? Everything has been installed according to the rules of the art? Are all other conditions met in order to be able to work correctly at the indicated location? Unless otherwise stated and explicitly stated in these operating instructions, safety accessories, etc. Damaged, must be repaired or replaced as soon as possible by authorized persons. Defective switches must be replaced by an authorized dealer. Do not use the machine when it cannot be switched off or on by means of a switch. When repairs are required, please contact your nearest dealer.
16. Before carrying out any adjustments or maintenance operations, it is essential that the motor is always switched off. This also applies to all work performed at the cutting head. Remove the spark plug from the engine.
17. Use only approved components. Only use spare parts identical to those you are replacing during maintenance or repair work. Please do not hesitate to ask your authorized dealer for advice. Do not use metal multi-piece swivel chains and flail blades.
18. When transporting and storing the tool, make sure that it is secure; Put the protective device on the blade and tool when it is being transported, stored, cleaned and maintained.
19. To avoid fuel leakage, damage and injury, be careful when handling and transporting the tool. Do not forget to put the protective device every time.
20. Do not use the appliance when you are tired, sick under the influence of alcohol or drugs.
21. Use only accessories and protections recommended by the manufacturer. It is recommended that your dealer can provide a list of recommended accessories if necessary. Use of parts not recommended by the manufacturer may result in injuries, accidents and malfunction of the tool.
22. Maintain a good balance and balance when operating the tool. Stay firm feet on the ground so as not to fall. Do not lean excessively, do not put yourself in positions that may unbalance you and hurt you. Use the harness supplied with the tool.
23. Regularly check if the cutting elements stop when the machine idles.
24. National regulation can restrict the use of the pruner.
25. Do not use the tool near electric power lines. There is a risk a danger and serious accidents.
26. Always have a correct working posture, stay stand, foot firmly on the floor. Hold firmly the tool.
27. Do not use the tool in dangerous operating positions; do not stand on a ladder.
28. The tool could be strapped, blocked or meet some dysfunction during operation. When a hazard is encountered, stop to use the machine. Observe the problem; clear the blockage if you are able to or ask for help. When removing a blockage, wear protective equipment.
29. We recommend to remove branches in sections.
30. There is risk of being struck by falling branches or branches that having hit the ground or having rebounding.
31. Keep firm footing and balance during operation.
32. Always the use the harness provided;

Warning!

The use of another cutting head or other accessories and extensions, even when explicitly advised, may constitute a risk of personal injury or property damage.

The machine must not be used for purposes other than intended. Any use deviating from these purposes must therefore be considered as unauthorized use. The user is solely responsible, thus releasing the manufacturer systematically from any liability, in case of bodily or material damage resulting from such unauthorized use.

The manufacturer's warranty is void if the machine it has been designed has been transformed or used in an unauthorized manner and such situation results in damage

Warning!

Even if the machine is used professionally, it is impossible to completely eliminate some residual risk. The type and design of the machine make it possible to establish the following potential risks:

- Contact with uncovered cutting head (cut wounds)
- Contact with the cutting elements in operation (injuries by cuts)
- Hearing impairment in the absence of proper hearing protection. Development of toxic dusts / fumes when used in confined spaces (vomiting / nausea)

In general, the machine has been designed for use in agriculture and forestry, gardening and landscaping, work in the forest or in a garden.













The manufacturer cannot be held liable for damage resulting from non-observance of the general instructions and the instructions contained in these operating instructions.

Emergency measures

Provide first aid based on the injury and seek medical attention as soon as possible.

Protect the injured person from other hazards and keep him calm.

Symbols on the machine

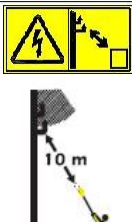
	Wear a protective helmet, and ear and eyes protection.		Do not use the tool under rain and do not expose it to humidity.
	Wear protective gloves.		Allowed maximal rotation speed. This symbol indicates the orientation of the cutting teeth when the assembly.
	Wear protective non-skid shoes.		Pay attention to the risk associated with carbon monoxide.
	Read instructions manual.		Warning! be careful of hot surfaces : risk of burning.
	The fuel is highly flammable, do not place it near a flame or a fire.		Keep hands and feet away from sharp accessories!
	Risk of projections. Keep bystanders away at least 15 m from the working area.		Guaranteed sound power level.
	Do not use the pruner near cables, power lines or telephone lines. When using the pruner, keep a safe distance of 10 meters from overhead power lines.		

Residual risks and preventive measures

Mechanical risks

Risk	Description	Preventive measures	Residual risks
Cutting, cutting injuries	The sharp filament and cutting blades can cause serious injury. Ensure that no people or animals are in the work area.	Ensure that no people or animals are in the working area	

Hanging	Cables and filaments can be caught by the cutting blade or the filament reel, which can damage the machine and cause injury. Remove all foreign objects from the area you want to mow before starting work.	Remove all foreign objects from the area you want to mow before starting work.	Danger
Shocks	Strong feedback shocks can occur when using the unit in dense bushes. When the knife remains blocked, violent shocks can be felt through the pole.	Do not penetrate too deep into dense bushes. Take your time and avoid the knife jamming.	

Negligence

Risk	Description	Preventive measures	Residual risks
Negligence in the use of personal protective equipment	Negligence in the use of personal protective equipment may result in serious personal injury	Use the necessary protective equipment	
Individual / Incorrect Behaviour		Be totally focused on your work	Residual risks cannot be completely

Residual risks from heat

Risk	Description	Preventive measures	Residual risks
Burns, frostbite	Contact with exhaust can cause burns	Allow the exhaust to cool after using	

Residual risk from noise

Risk	Description	Preventive measures	Residual risks
Loss of hearing	Regular / prolonged use of the pruner without the use of hearing protectors can cause loss of auditory acuity.	Always wear ear protectors.	

Residual risks from others materials and substances

Risk	Description	Preventive measures	Residual risks
Contact aspiration	Exhaust gas may have a harmful effect	Only use the machine outdoors and in accordance with its intended purpose	
Fire or explosion	The mix of fuel is flammable	Do not smoke and manipulate fire near the tool and fuel	

Risks from vibration

Risk	Description	Preventive measures	Residual risks
Vibration of the body	A prolonged use of the tool could have a negative effect on human health	Do some rests	

Others risks

Risk	Description	Preventive measures	Residual risks
Projected objects	Stones and pieces of wood projected in the vicinity are likely to injure people or animals.	Ensure that no persons or animals are in the hazardous area and wear suitable protective clothing, hearing protection and a visor.	

Sliding, stumbling and falling	On uneven floors, damage can be caused by stumbling	Be sure to always be on your support and wear non-slip shoes	
--------------------------------	---	--	--

Disposal / Recycling

Disposal instructions are indicated in the form of pictograms attached to the machine or packaging. The meaning of the various symbols is given in the chapter "Symbols attached to the machine".

Requirements to the user

Before using the machine, the user must read the instruction manual carefully

Qualification

The machine must be operated by a qualified person who has had special training with a specialist.

Minimum Age Required

Use of the machine is only permitted for persons aged 16 or older. This point does not apply to the use by young people in training, when they work with the machine as part of their vocational training with the aim of acquiring this know-how under the supervision of a trainer.

Special requirements to the user

Before using the machine, the user must read the instruction manual carefully.

The tool must be used by a qualified person who had training provided by a specialist.

Use of the machine is only permitted for persons aged at least 16 years. This point does not apply to the use by young people in training when they work with the machine as part of their vocational training with the aim of acquiring this know-how under the supervision of a trainer.

3. YOUR PRODUCT

Main unit

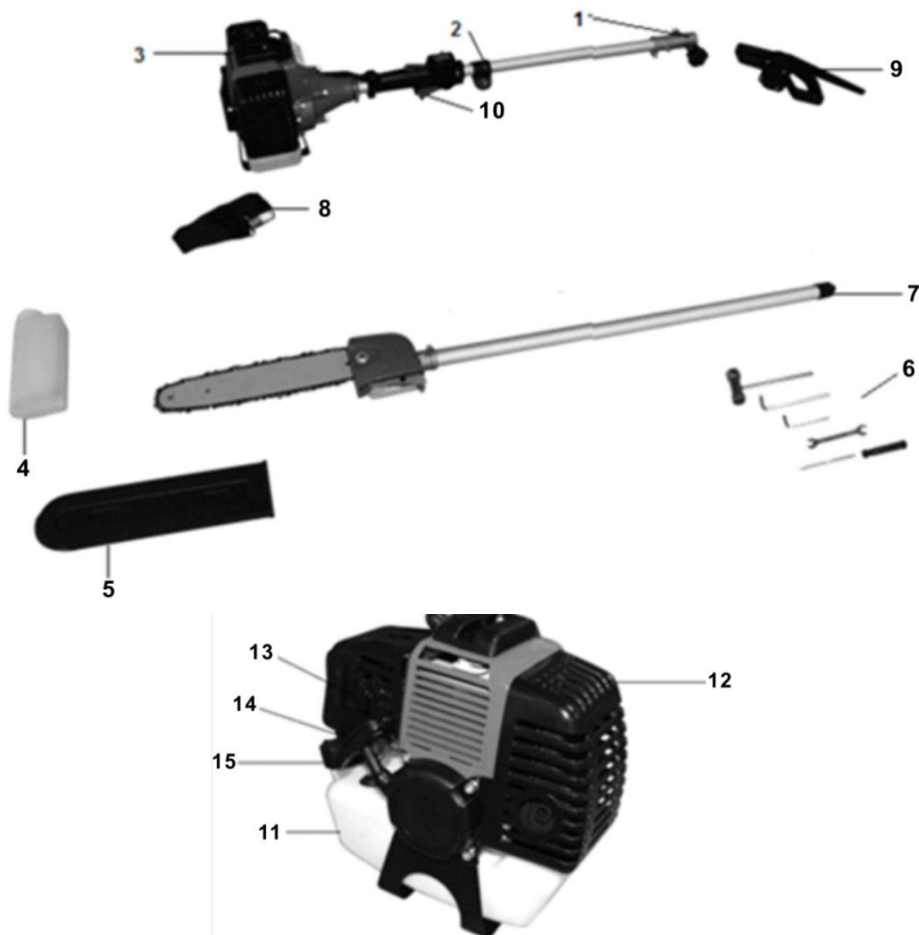

1	Mounting tube (extension tube and cutting head)	6	Assembly tools (wrenches and screwdrivers)	11	Fuel tank
2	Device for installing the shoulder strap	7	Pruner	12	Exhaust pipe
3	Engine	8	Strap	13	Choke control
4	Bottle for the oil mixture	9	handle	14	Starter
5	Protection of the blade	10	Power Switch	15	Tank cap

Pole mounted pruner



- 1- Tube
- 2- Oil tank for lubrication
- 3- Cutting head

4. ASSEMBLY

NOTE: This model comes with a stretch tube. This tube must be installed on the fixing tube of the machine then the accessories will be installed on this extensible tube.

Main unit

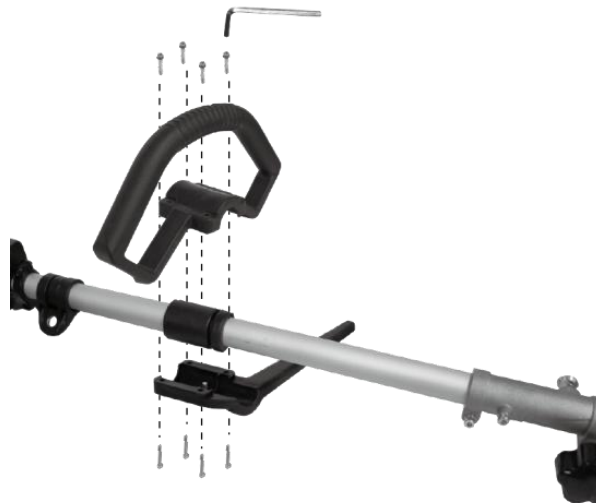

Install the front handle as shown in the picture below. Be sure to orient the stem toward the hole. Do not fasten the screws until you have set the most comfortable working position with the straps. The front handle must be oriented as shown in the picture.



Tube installation

- Loosen the clamping knob
- Connect the cutting blade to the machine tube (Make sure the lock is securely engaged in the mounting hole).
- Tighten the knob. Make sure the connection is secure.
- If need to use the additional extension tube, and the additional tube first as explained above, then install the pruner on the extension tube.

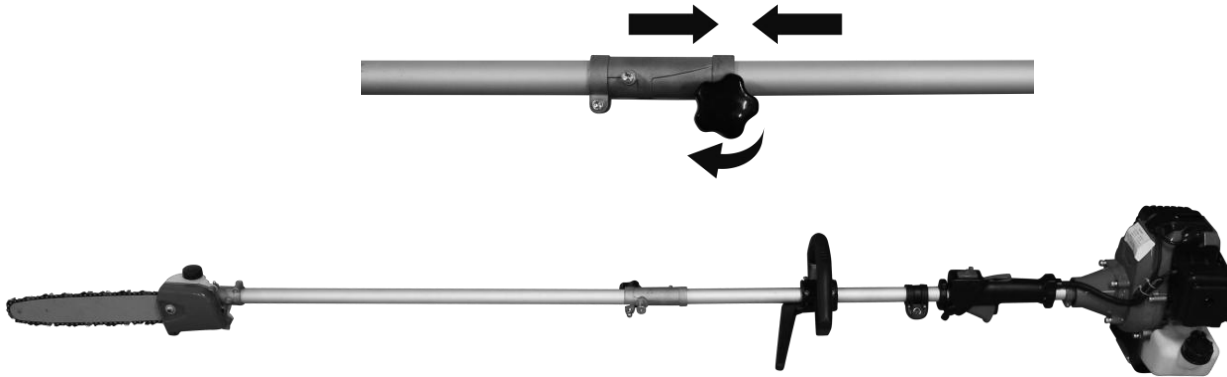

Assembly of the chain guide and the cutting chain:

Remove the safety screw and remove the guard.



Place the chain guide so that the safety pin on the chain engages in the chain's teeth. Make sure that the direction of movement of the cutting chain is correct. Install the chain guard and tighten the fastening screw.



Adjusting the chain tension

The chain must not have too much clearance, but it must be possible to lift the chain a few millimeters from the guide rail.

- Loosen the fixing screw.
- Slightly lift the end of the chain guide
- Check the cutting chain for ease of operation by turning it manually.
- Adjust the tension of the chain by means of the screw for adjusting the tension of the chain (4) so that the chain can be lifted a few millimeters from the center of the guide rail.

- Secure the safety screw.

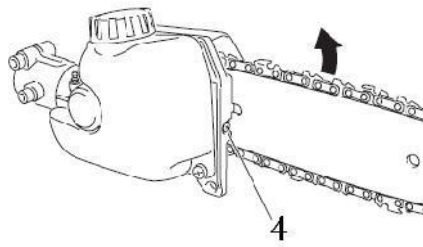

Installation of the harness

Install the harness latch into its dedicated device, located on the toolbar.

The shoulder strap is equipped with an emergency release mechanism. To detach the machine from the shoulder strap in emergency situations, follow the instructions described below.

WARNING!

Check the emergency release mechanism BEFORE operating the machine.

Be sure to hold the machine when operating the emergency release mechanism.

When holding the machine firmly with your right hand, press both sides of the belt buckle.

5. FILLING TANK

Warning: Gasoline is highly flammable. Keep the fuel in specially designed cans.

- Only fill the tank outside and do not smoke during the operation.
- Fill the tank before starting the engine. Never remove the fuel tank cap, add fuel while the engine is still running, or while the engine is still warm.
- Avoid overfilling the tank: When excess fuel has escaped, do not attempt to start the engine, but move the machine away and avoid any sources of ignition in the vicinity until the fuel vapors have dissipated.
- Fully tighten all fuel filler caps and cans.
- Fill the tank on the floor.
- The engine must be started at a distance of at least 3 meters from where the fuel tank has been filled.
- Switch off the engine before adding fuel. Shake the mixture thoroughly before filling the tank.
- Store gasoline in tanks specially designed for this purpose.
- Fill the fuel tank of your appliance outdoors and avoid smoking during work.
- Fill the tank before starting the engine. Never open the fuel tank cap or fill fuel tank while the engine is running or the engine is still hot.
- Avoid spilling gasoline: When gasoline is spilled, do not start the machine and move it away from where the gasoline has spilled to avoid possible sources of fire.
- Screw all caps and tank cover carefully

Gasoline is highly flammable. Do not smoke and avoid sparks or open flames near the fuel. Turn the engine off and allow it to cool before filling the fuel tank. Filling must be done externally, ideally on the bare ground. Leave at least 3 meters from where you filled the tank to start the engine.

The engine requires oil specially adapted for two-stroke engines with an air cooling system. Use quality oil enriched with corrosion-inhibiting products explicitly provided for two-stroke engines with an air cooling system (JASO FC or ISOEGC).

Do not use BIA or TCW OIL (suitable for 2-stroke engines equipped with a water cooling system).

SUGGESTED PROPORTIONS: GASOLINE 40: OIL 1

Exhaust emissions are regulated by the basic technical characteristics of the engine and its

components (carburation, adjustment of spark plugs, control of exhaust opening and closing times) in the absence of accessories or a catalyst during combustion.

- These motors are designed for use with unleaded gasoline.
- Always use gasoline with a minimum octane rating of 90RON.
- Using gasoline with a lower octane rating may cause an increase in engine temperature, causing problems with the engine, including seizure.
- Using unleaded gasoline prevents unnecessary pollution in the interests of your health and the protection of the environment.
- Using gasoline or oil of lesser quality can damage seal rings, ducts or fuel tank.

Prepare the mixture

IMPORTANT!

MIX THE MIXTURE CAREFULLY.

- a. Measure the fuel and oil needed for the fuel mixture.
- b. Pour a little gasoline into a clean container provided for this purpose.
- c. Add all the oil before stirring the can.
- d. Add remaining gasoline and shake the can for at least 1 minute. Certain oils mix with difficulty because of the substances they contain. Sufficient agitation of the mixture is essential to ensure proper operation over the life and power of the engine. If your fuel mixture is not stirred sufficiently, the poor and inadequate mixture may increase the risk of seizure.
- e. Identify the can by locating it with a distinctive emblem in order to always know what is there.
- f. Indicate the substances contained and the proportions of the mixture.

Filling the tank

Unscrew the tank cap. Place the tank cap in a clean, dust-free place.

- a. Fill the tank to 80% of its capacity.
- b. Screw the fuel cap back on. Clean the fuel tank cap and the area around after filling the fuel tank. Eliminate overflow of fuel mixture by rubbing.

NOTE: When filling, avoid:

- **OIL-FREE FUEL (PURE FUEL) - This can quickly cause serious damage to the interior of the engine components.**
- **GASOHOL - may cause deformation of rubber or plastic parts and cause engine lubrication to stop.**
- **OIL FOR 4-TIME ENGINES - causes clogging of the spark plug, clogs the exhaust channel or leads to seizure.**

Fuel mixtures stored for more than one month may, if used, clog the carburetor and cause the engine to malfunction.

If the unit is to be stored for an extended period of time, the tank must be cleaned after being emptied. Leave the engine running to remove the remaining fuel from the carburetor.

Observe local regulations when disposing of used containers.

6. UTILISATION

Start the engine

1. Do not start the appropriate module of the machine until all components have been connected correctly! Attach the cutting blade of the pruner with a torque of 20 Nm and the cutting head of the mower with a tightening torque of 15Nm.

WARNING! Fill the fuel tank before tightening the fuel tank cover.

- Put the machine on a level, solid floor. Keep the cutting head away from the ground and away from surrounding objects (Fig.5).

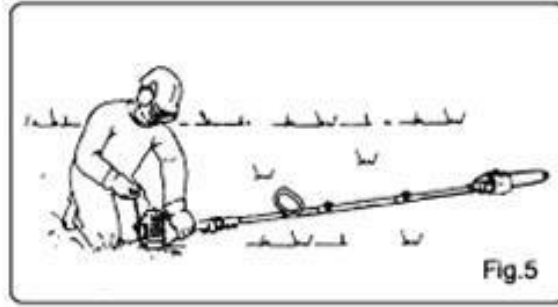

- Press the priming bulb 5 to 8 times until fuel flows through the clear hose.
- Position the choke in the closed position.

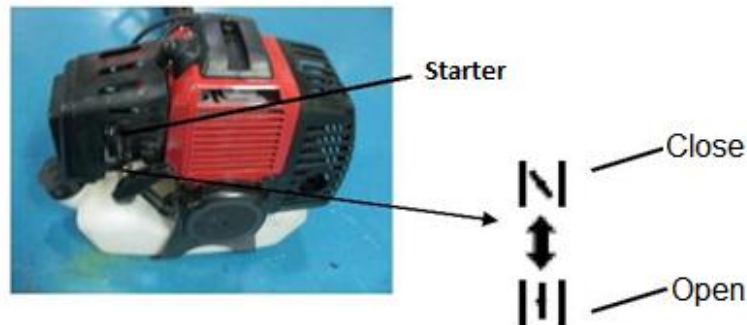

- Set the STOP switch to position "I". Make sure the cutting head is clear. Store the machine on a level, solid floor.
- Keep the machine on the ground safely and then pull the starter until the engine starts

WARNING!

The machine is equipped with a centrifugal clutch system.

When starting the engine, place the machine on a level, clean floor and hold it firmly to prevent the sharp components or the throttle lever from coming into contact with any objects when the engine is started.

IMPORTANT!

- Avoid pulling the starter to the end or return the cable by suddenly releasing its handle. This can cause the engine to fail.
- Position the choke in the "open" position and restart the engine.
- Let the engine warm up a few minutes before starting work.

NOTE

- When restarting the engine directly after stopping it, keep the choke switch in the "open" position.
- Overheating complicates engine starting due to overfilling of fuel. If the engine does not start after several attempts, open the starter and press the starter several times, or remove and dry the spark plug.

Stop the engine

- Release the throttle lever and let the engine run for about 30 seconds.
- Set the stop switch to the STOP position.

IMPORTANT!

- Except in case of emergency, do not switch off the engine by pulling on the choke lever.
- If the engine does not stop by pressing the stop switch, move the choke to the closed position.

Use of the pole pruner

Never use the tool at an angle of more than 60 °. The correct operation of the pruner is not impaired at angles greater than 60 °, but the risk of injury increases due to sudden drops of branches. Pay attention to the floor in front of you when using the appliance. This allows you to avoid tripping over branches on the ground. Never use the saw without oil. Use a biodegradable chain oil. The pruning machine uses a low rebound chain. In addition, special attention has been paid to the construction of the device to prevent the smallest possible rebounds given the technical conditions given. Nevertheless, a slight rebound can not be ruled out by using the upper cutting blade. Expect a rebound when using this side of the blade or when the top of the blade comes into contact with another branch. The device should always be used with both hands. The thin branches can be cut at once. To prevent a branch from splitting or bending, it is advisable to slice it end to end. When slitting longer branches, the branch should be cut from the bottom. First cut the branch from below at a point away from where you want to saw the branch. The notch must have a depth between one third and one half the thickness of the branch. This prevents the branch from breaking when you cut it from the top a little further away from the trunk. To finish, saw the stump by making a straight cut. If you wish, you can seal the cut using a suitable product.

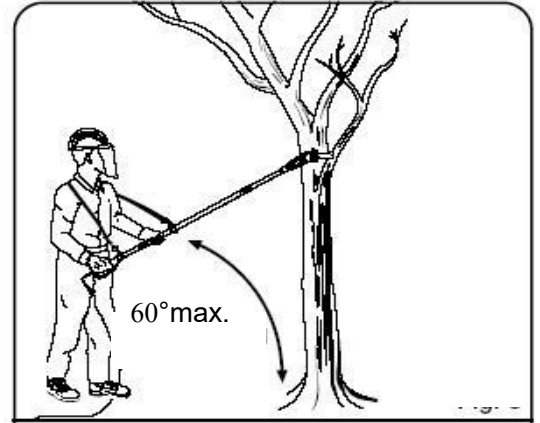

7. CARE AND MAINTENANCE

Warning! The following instructions refer to normal operating conditions. In the presence of more difficult working conditions or when the work is carried out for a prolonged period, it is necessary to reduce the indicated intervals. Care and maintenance must be done after each use of the tool.

After work, it is essential to always check the entire machine and clean it.

Regular checks and maintenance:

- **Check the air filter (to be cleaned if necessary)**
- **Check spark plugs (replace if necessary)**
- **The correct operation and quantity of the cutting wire.**

Always switch the drive unit off when performing any maintenance or repair work.

A) Safety and Maintenance Instructions

The machine may only be used if it is serviced and maintained regularly. Insufficient maintenance can lead to emergencies and unforeseen accidents.

Repairs should only be carried out by authorized specialists with the necessary technical knowledge. Interventions by non-specialists may damage the machine or be hazardous to safety.

Follow the instructions below:

- Ensure that all nuts, bolts and screws are tightened to ensure that the machine meets all safety conditions
- Never store the machine with fuel remaining in the tank in a building where gasoline vapors may come in contact with flames or sparks.
- Allow the engine to cool before storing it in an enclosed area.
- To reduce the risk of fire, remove grease, from the engine, muffler and fuel compartment.
- Replace worn or damaged components.
- When the fuel tank is to be emptied, do so outdoors.

- Do not attempt to repair the machine unless authorized to do so.
- Use only spare parts and accessories recommended by the manufacturer.
- Checking for loose fasteners, fuel leaks and damaged parts (e.g. cracks in the saw blade).
- Always check and adjust the guide bar and chain with the engine stopped.

B) Maintenance plan

To carry out the regular maintenance operations, please refer to the following table
 Stop the engine systematically before performing any maintenance on the machine. When all parts have stopped rotating, remove the cable from the spark plug so that maintenance can begin. Never repair the cutting attachments by welding, grinding or modifying their shape. This can cause serious injury.

Never attempt to perform maintenance operations not listed in this manual. All repairs must be carried out by an authorized specialist.

		Before operation	After operation	Filing	Once a year	Once a year	If damaged	If required
Machine	Visual inspection (leak)	•		•				
Throttle lever	Check of the correct operation	•						
Fixation of the throttle lever		•						
Stop switch	Checking	•						
Fuel tank	Cleaning of the exterior of the tank		•					
Cutting accessories	Checking (wearing)							•
Transmission case	Grease					•		•
Air filter	Checking/cleaning	•			•			
	Replacement if too dirty or used				•			•
Housing	Cleaning		•					
Cylinder	Cleaning							•
Spark plug	Cleaning, adjustment and replacement if necessary					•		•
All fixation	Tighten						•	•
Exhaust pot	Checking, cleaning, replacement	•						•
		•			•			

 Always shut down the engine before performing any maintenance on the machine. When all parts have stopped rotating, remove the cable from the spark plug in order to start maintenance.

 Never repair cutting accessories by welding, rectifying or modifying their shape. This can cause serious injury.

 Never attempt to carry out maintenance operations that are not included in this manual. All repair work must be performed by an authorized specialist repairer.

Replacement of the spark plug

Remove the cover of the spark plug, unscrew the spark plug and then replace it.

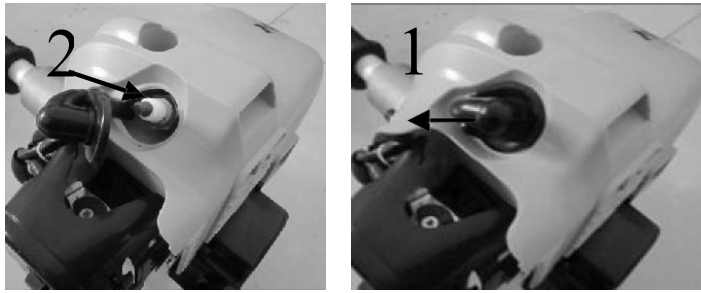

Sharpening

Sharpening shall be done by a qualified service or by an experimented person who must follow the below instructions. Do not perform sharpening if you do not have the knowledge to do it.

Be careful to file all cutters to the specified angles and to the same length, as fast cutting can be obtained only when all cutters are uniform.

Tighten the chain tension enough that the chain does not wobble. Do all of your filing at the midpoint of the bar. Wear gloves for protection.

Use a round file and holder.

Keep the file level with the top plate of the tooth. Do not let the file dip or rock.

Using light but firm pressure, stroke towards the front corner of the tooth. Lift file away from the steel on each return stroke.

Put a few firm strokes on every tooth. File all left hand cutters in one direction. Then move to the other side and file the right hand cutters in the opposite direction. Occasionally remove filings from the file with a wire brush.

8. TRANSPORT AND STORAGE

Bring cleaning and maintenance to the tool before storage.

When the machine is not used for an extended period of time (1 month), the following measures should be taken:

- Empty the oil and fuel tank.
- Disassemble and clean the thread spool and cutting blade.
- Dry the spool of wire and the cutting blade using a cloth.
- Rub the outside of the machine using a soft, damp cloth.
- Store the machine in an enclosed and well ventilated place. Keep the machine so that it is not accessible to children.
- Store the machine in a dry place.
- The pruning machine must be properly packaged to prevent cuts.
- Use the baffles on cutting accessories with a metal knife.

9. TECHNICAL INFORMATION

Type of engine	RY1E44F-5 (air cooled 2-stroke petrol engine)
Engine speed	Max. 10000 min ⁻¹
Engine idling speed	3200±300 min ⁻¹
Engine speed with clutch engages	Min. 4500min ⁻¹
Engine displacement	52 cm ³
Maximal power	1.4 kW
Volume of fuel tank	1200 cm ³
Volume of oil tank	140 cm ³

Machine mass (without fuel, cutting attachment and harness)	7.5 kg
Cutting length	300/260 mm
Chain pitch	9.525mm
Chain gauge	1.27mm
Sprocket (number of teeth x pitch)	7 Teeth x 9,525mm
Cutting attachment	Guide bar: Kangxin AL12-44-507P Chain: Kangxin 3/8 LP-44.
Carburettor.	MZ15A/Stable, MR15A2-43A/HLIC, 12S21/Huayi, WYK445/Walbro, MZ15-CB2A/BIG DINT, RG44-5/Royal Garden;
Spark Plug	BOSCH L8RTF, NHSP LD L8RTF, TORCH L7RTC, NGK BP MR7A, CDK L8RTC
Vibration	Front handle: 5.84 m/s ² K= 1,5 m/s ² Rear handle: 8.16 m/s ² K= 1,5 m/s ²
Sound pressure level	L _{PA} =96.2dB(A) ; K=3 dB(A)
Sound power level	L _{WA} =109.7dB(A) ; K=3 dB(A)
Guarantee sound power level	117 dB(A)

10. TROUBLESHOOTING

Problems	Causes	Resolutions
The tool cannot be started	The starting process is not followed	Follow the instructions of use of this manual
	Spark plug dirty or moist	Clean the spark plug or replace it by a new one
	Incorrect carburettor adjustment	Contact your dealer or contact SWAP
The tool starts but no in a full power	Non correct setting of the starter	Open the starter
	Air filter is dirty	Clean the air filter
	Incorrect carburettor adjustment	Contact your dealer or contact SWAP
The engine cannot reach its maximal power	Non correct gap between the electrode and the spark plug	Clean the spark plug and adjust the gap between the electrodes or replace them with a new one
	Incorrect carburettor adjustment	Contact your dealer or contact SWAP
The engine generate of lot of smoke	Incorrect mix of the tank	Do a correct mix of the fuel (see the corresponding chapter)
	Incorrect carburettor adjustment	Contact your dealer or contact SWAP

11. DECLARATION OF CONFORMITY



Genpower Ltd

Isaac Way London Road Pembroke Dock Pembrokeshire SA72 4RW United Kingdom

Declare that the tool:

PETROL POLE PRUNING MACHINE

Ref: HPS5230

Serial number: 20250800671-20250800820

Is in conformity with the Directive Machine 2006/42/EC and the national regulation transposing it

Also in conformity with the following European regulation:

Machine Directive 2006/42/EC

EMC Directive 2014/30/EU

Emission Directive (UE) 2016/1628

Noise Directive 2000/14/EC Annex V and 2005/88/EC

Sound power level: L_{wA} , $a_v = 109.7$ dB(A); $K=3$ dB(A)

Guarantee sound power level: 117 dB(A)

Is also in conformity with the following standards:

EN ISO 11680-1:2021

EN ISO 14982:2009

Notified at the EU under 0905

**Intertek Deutschland GmbH, Stangenstraße 1, 70771 Leinfelden-Echterdingen
Tel.: +49 711 27311-0 E-Mail: gs@intertek.com web: www.intertek.de/zeichen**

EC-type certification: 15SHW1932-06

Responsible of the Technical file: Mr.Mark.Z

Done at Pembrokeshire: 23/06/2025

Name of QC manager: Roland Llewellyn

12. WARRANTY

HYUNDAI

WARRANTY

The manufacturer guarantees the product against defects in material and workmanship for a period of 2 years from the date of the original purchase. The warranty only applies if the product is for household use. The warranty does not cover breakdowns due to normal wear and tear.

The manufacturer agrees to replace parts identified as defective by the designated distributor. The manufacturer does not accept responsibility for the replacement of the machine, in whole or in part, and/or ensuing damage.

The warranty does not cover breakdowns due to:

- insufficient maintenance.
- abnormal assembly, adjustment or operations of the product.
- parts subject to normal wear and tear.

The warranty does not extend to:

- shipping and packaging costs.
- using the tool for a purpose other than that for which it was designed.
- the use and maintenance of the machine done in a manner not described in the user manual.

Due to our policy of continuous product improvement, we reserve the right to alter or change specifications without notice. Consequently, the product may be different from the information contained therein, but a modification will be undertaken without notice if it is recognized as an improvement of the preceding characteristic.

READ THE MANUAL CAREFULLY BEFORE USING THE MACHINE.

When ordering spare parts, please indicate the part number or code, you can find this in the spare parts list in this manual. Keep the purchase receipt; without it, the warranty is invalid. To help you with your product, we invite you to contact us by phone or via our website:

- **+33 (0)9.70.75.30.30**
- **<https://services.swap-europe.com/contact>**

You must create a "ticket" via the web platform.

- Register or create your account.
- Indicate the reference of the tool.
- Choose the subject of your request.
- Describe your problem.
- Attach these files: invoice or sales receipt, photo of the identification plate (serial number), photo of the part you need (for example: pins on the transformer plug which are broken).



13. PRODUCT FAILURE

WHAT TO DO IF MY MACHINE BREAKS DOWN?

If you bought your product in a store:

- a) Empty the fuel tank if your product has one.
- b) Make sure that your machine is complete with all accessories supplied, and clean! If this is not the case, the repairer will refuse the machine.

Go to the store with the complete machine and with the receipt or invoice.

If you bought your product on a website:

- a) Empty the fuel tank if your product has one..
- b) Make sure that your machine is complete with all accessories supplied, and clean! If this is not the case, the repairer will refuse the machine.
- c) Create a SWAP-Europe service ticket on the site: <https://services.swap-europe.com> When making the request on SWAP-Europe, you must attach the invoice and the photo of the nameplate (serial number).
- d) Contact the repair station to make sure it is available before dropping off the machine.

Go to the repair station with the complete machine packed, accompanied by the purchase invoice and the station support sheet downloadable after the service request is completed on the SWAP-Europe site

For machines with engine failure from manufacturers BRIGGS & STRATTON, HONDA and RATO, please refer to the following instructions.

Repairs will be done by approved engine manufacturers of these manufacturers, see their site:

- <http://www.briggsandstratton.com/eu/fr>
- <http://www.honda-engines-eu.com/fr/service-network-page;jsessionid=5EE8456CF39CD572AA2AEEDFD290CDAE>
- <https://www.rato-europe.com/it/service-network>

Please keep your original packaging to allow for after-sales service returns or pack your machine with a similar cardboard box of the same dimensions.

For any question concerning our after-sales service you can make a request on our website <https://services.swap-europe.com>

Our hotline remains available at +33 (9) 70 75 30 30.



14. WARRANTY EXCLUSIONS

THE WARRANTY DOES NOT COVER:

- Start-up and setting up of the product.
- Damage resulting from normal wear and tear of the product.
- Damage resulting from improper use of the product.
- Damage resulting from assembly or start-up not in accordance with the user manual.
- Breakdowns related to carburetion beyond 90 days and fouling of carburetors.
- Periodic and standard maintenance events.
- Actions of modification and dismantling that directly void the warranty.
- Products whose original authentication marking (brand, serial number) has been degraded, altered or withdrawn.
- Replacement of consumables.
- The use of non-original parts.
- Breakage of parts following impacts or projections.
- Accessories breakdowns.
- Defects and their consequences linked to any external cause.
- Loss of components and loss due to insufficient screwing.
- Cutting components and any damage related to the loosening of parts.
- Overload or overheating.
- Poor power supply quality: faulty voltage, voltage error, etc.
- Damages resulting from the deprivation of enjoyment of the product during the time necessary for repairs and more generally the costs related to the immobilization of the product.
- The costs of a second opinion established by a third party following an estimate by a SWAP-Europe repair station
- The use of a product which would show a defect or a breakage which was not the subject of an immediate report and/or repair with the services of SWAP-Europe.
- Deterioration linked to transport and storage*.
- Launchers beyond 90 days.
- Oil, petrol, grease.
- Damages related to the use of non-compliant fuels or lubricants.

* In accordance with transport legislation, damage related to transport must be declared to carriers within 48 hours maximum after observation by registered letter with acknowledgement of receipt.

This document is a supplement to your notice, a non-exhaustive list.

Attention: all orders must be checked in the presence of the delivery person. In case of refusal by the delivery person, it you must simply refuse the delivery and notify your refusal.

Reminder: the reserves do not exclude the notification by registered letter with acknowledgement within 72 hours.

Information: Thermal devices must be wintered each season (service available on the SWAP-Europe site). Batteries must be charged before being stored.

HYUNDAI

POWER PRODUCTS



For inquiries, please contact:

Genpower Ltd

Isaac Way London Road Pembroke Dock Pembrokeshire SA72 4RW United Kingdom

T. +44 (0)1646 687880 | F. +44 (0)1646 686198

www.hyundaipowerequipment.co.uk

Fabriqué en République Populaire de Chine(PRC)

Importer by Genpower Ltd

Licensed by Hyundai Corporation Holdings, Korea